

787621XXv03

Directional Coupler 4.3-10
PIM -160dBc
380-6000

Directional Coupler 380-6000MHz

Type	78762105v03	78762106v03	78762108v03	78762110v03
Coupling Value (dB)	5	6	8	10
Coupling Bias (dB)	±1.8	±1.8	±1.8	±1.1
Insertion Loss (dB)	≤3.0	≤2.20	≤1.7	≤0.8
Isolation (dB)	≥21	≥23	≥25	≥28

Type	78762115v01	78762120v01	78762130v01
Coupling Value (dB)	15	20	30
Coupling Bias (dB)	±2.2	±2.2	±2.2
Insertion Loss (dB)	≤0.8	≤0.3	≤0.3
Isolation (dB)	≥30	≥35	≥38

Electrical Specifications	
Frequency Range (MHz)	380-6000
Impedance (Ω)	50
IM3 (dBc, @2x43dBm)	≤ -160
Connector Type	4.3-10
Max. Power Rating (W)	200
Peak Power (W)	1,200

Mechanical and Environmental Specifications	
Dimension (mm)**	156.9 x 44 x 31
Weight (kgs)*	0.675
Colour	Light Grey
Mounting	Wall Mount
Operating Temp (°C)	-40 to +80
Ingress Protection Class	IP65
Packing Dimension (mm)	240 x 80 x 35
SKU (unit per box)	30 pcs per inner carton

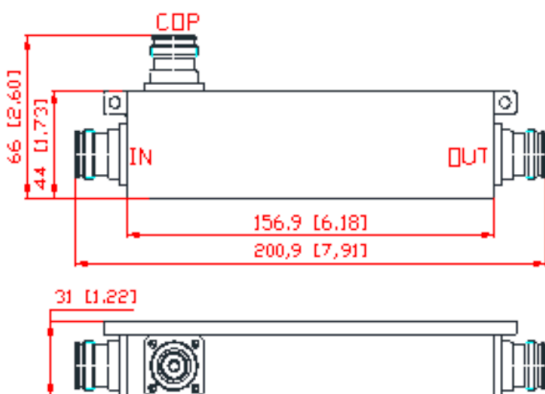

Input → Output: DC pass
 Input → COP: no DC pass
 Output → COP: no DC pass

* including mounting bracket and connectors
 ** excluding mounting bracket and connectors